

Signal Directors **SP-120 and DC8/10/12**

Our JXP style **Signal Directors**, are high quality Signal Splitters made for the MB Arris Amplifiers . They are engineered and built with the intent to be the **best** in the industry.

Part Number Matrix

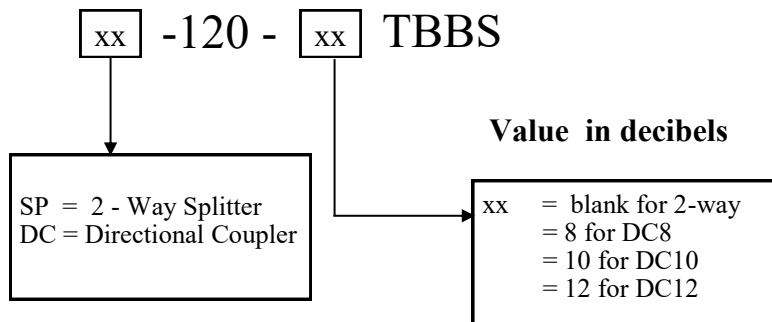

Specifications

Band Pass	5 - 1218MHz
Band Pass Flatness	+/- 0.5dB
Return Loss	18dB min
Color	Blue



Splitter

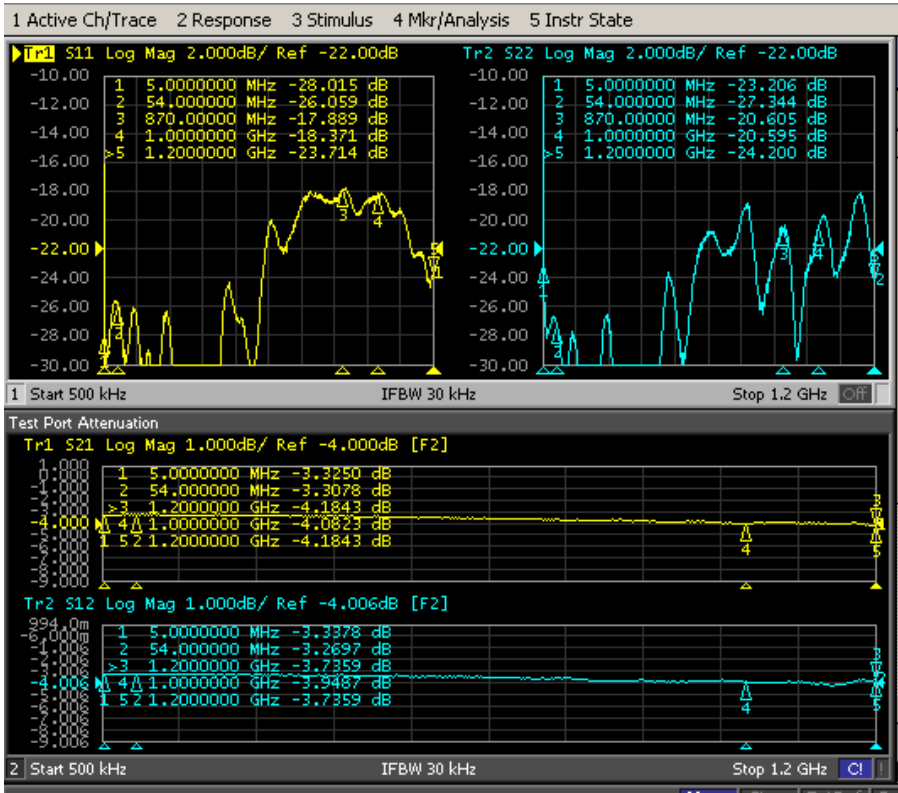

Port 1

Top
Yellow = RL In
Blue = RL out

Bottom
Yellow = FWD
Blue = Return

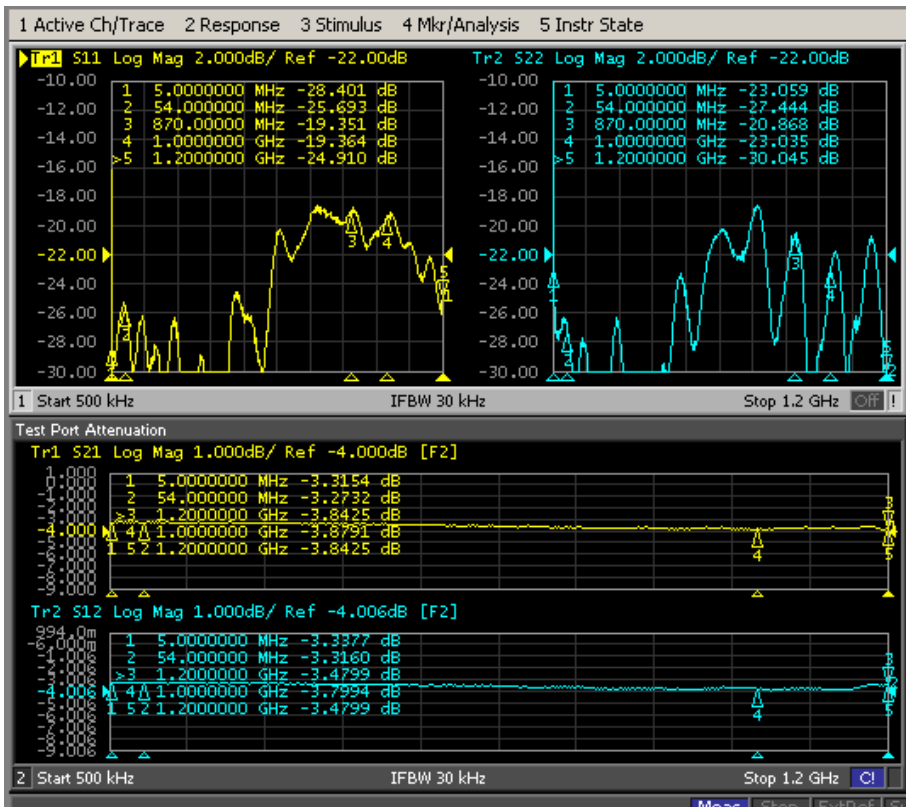

Port 2

Top
Yellow = RL In
Blue = RL out

Bottom
Yellow = FWD
Blue = Return



DC 8

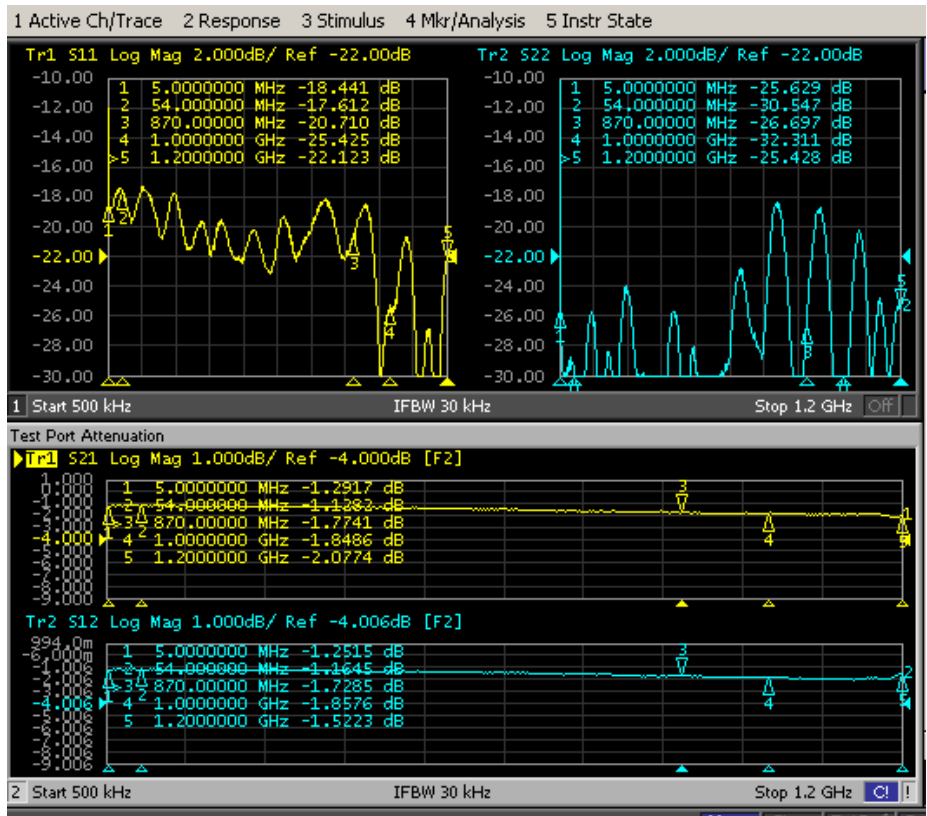

Port 1

Top
Yellow = RL In
Blue = RL out

Bottom
Yellow = FWD
Blue = Return

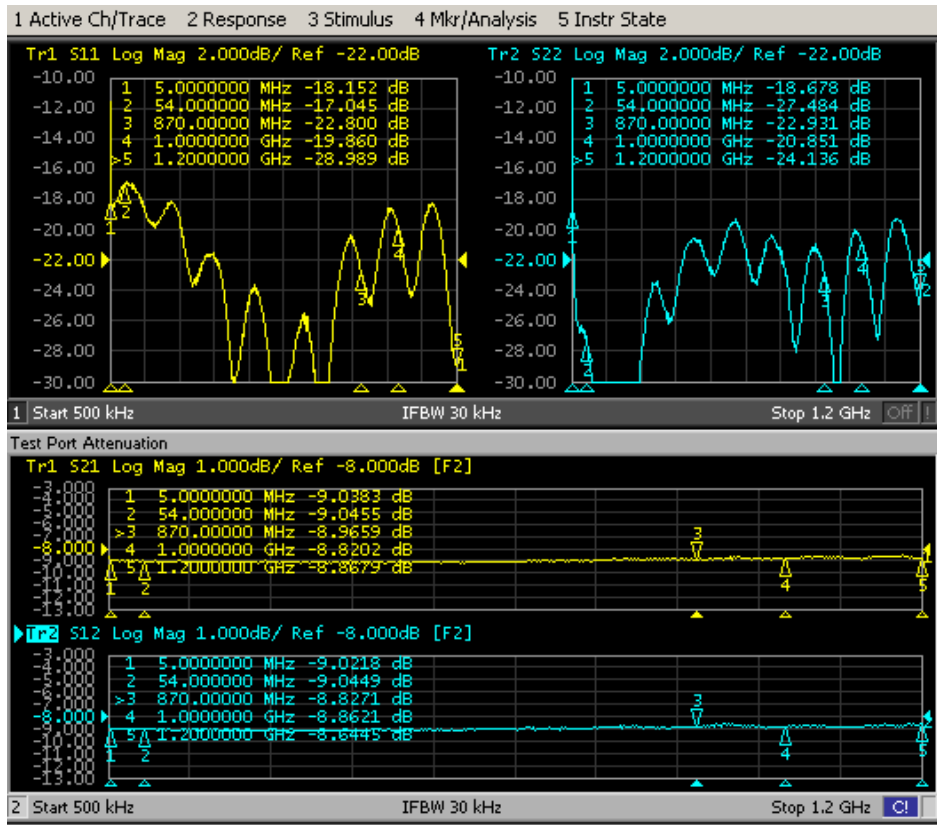

Port 2

Top
Yellow = RL In
Blue = RL out

Bottom
Yellow = FWD
Blue = Return



DC 10

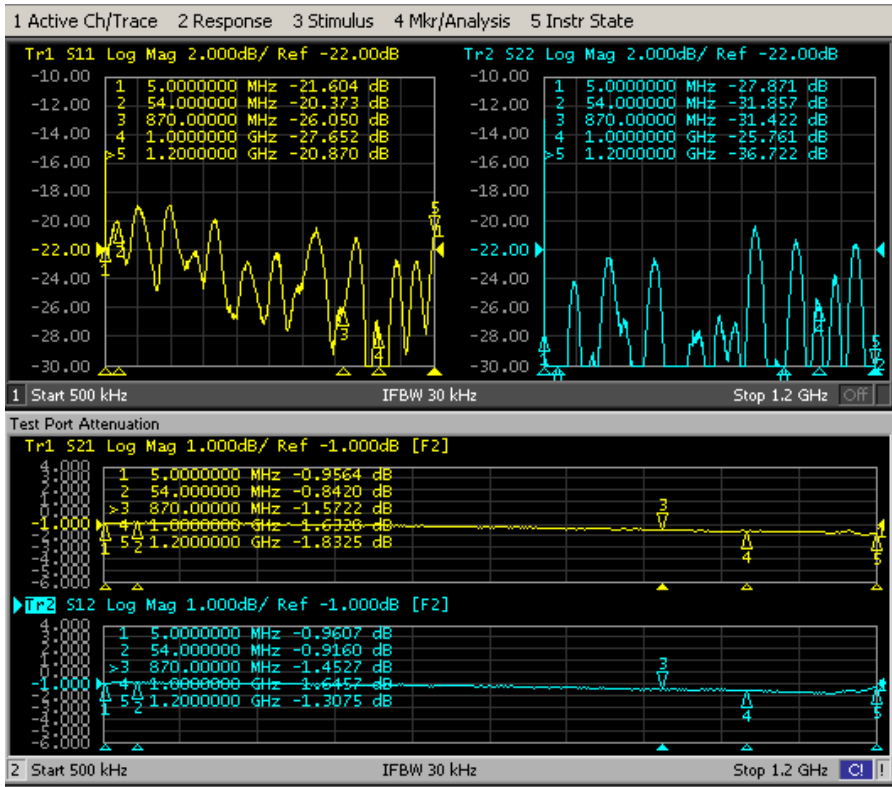

Port 1
Top
Yellow = RL In
Blue = RL out

Bottom
Yellow = FWD
Blue = Return

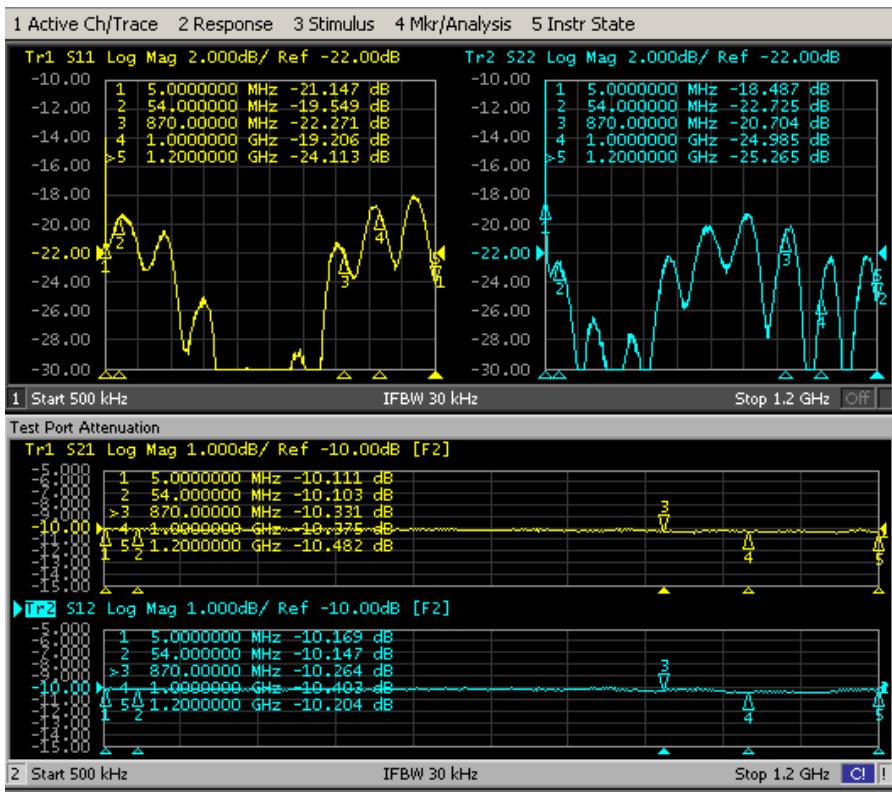

Port 2
Top
Yellow = RL In
Blue = RL out

Bottom
Yellow = FWD
Blue = Return



DC 12

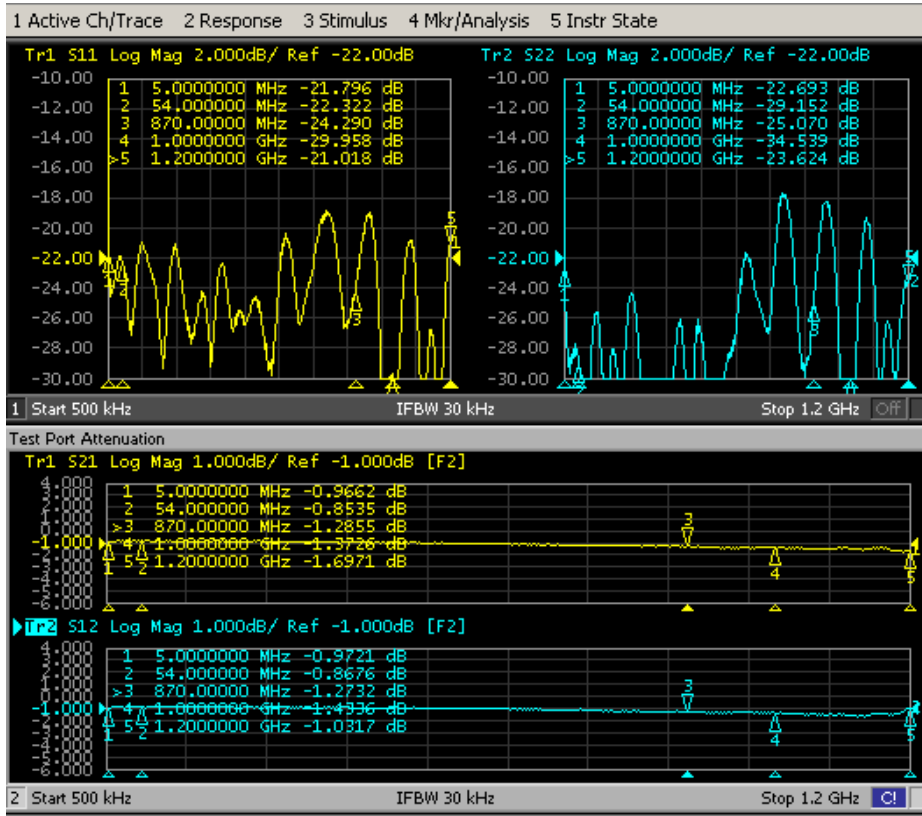

Port 1

Top
Yellow = RL In
Blue = RL out

Bottom
Yellow = FWD
Blue = Return

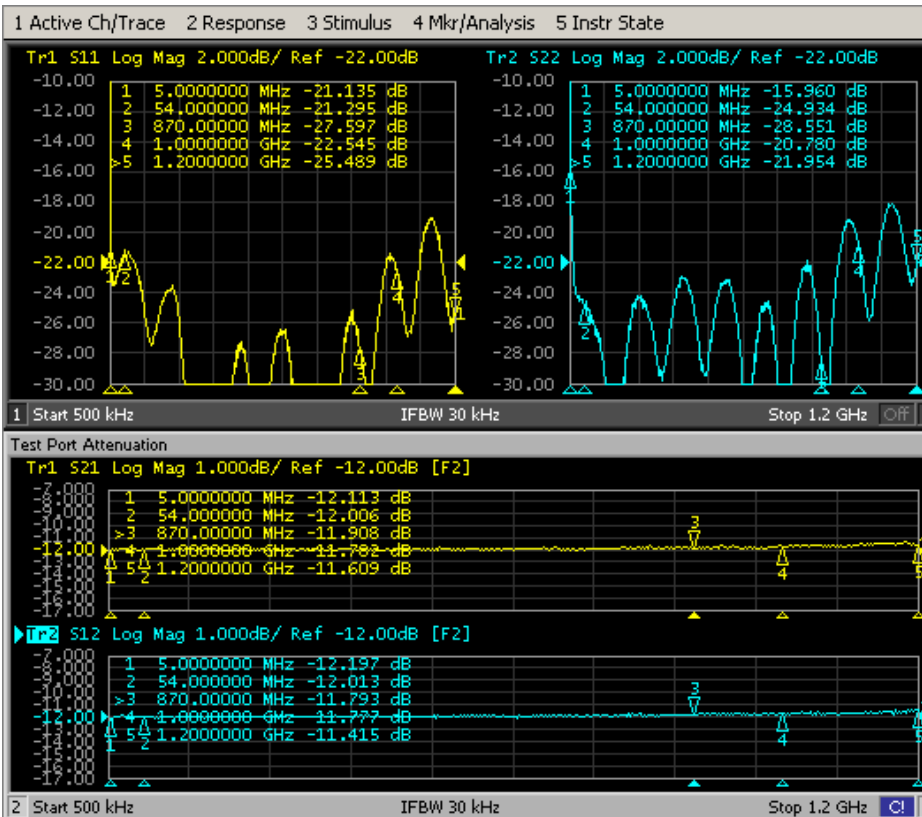

Port 2

Top
Yellow = RL In
Blue = RL out

Bottom
Yellow = FWD
Blue = Return